

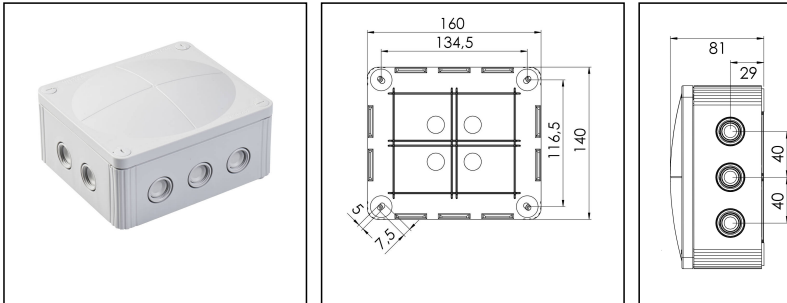

## COMBI 1210/5

Junction box, polypropylene



Product illustrations are exemplary and may differ from the chosen product. Further variants and individual customization, we will gladly provide you on request.



<b>Material</b>	Polypropylene
<b>Material sealing gasket</b>	TPE
<b>Temp. range min</b>	-30 °C
<b>Temp. range max</b>	100 °C
<b>Temperatures during install.</b>	-5 °C - 60 °C
<b>Protection class</b>	IP66/67
<b>Glow wire test</b>	750 °C
<b>Voltage</b>	690 V
<b>Terminals/poles</b>	10 mm <sup>2</sup>
<b>Terminals/poles</b>	5 x 10mm <sup>2</sup>
<b>Fixing</b>	4 internal openings
<b>Ø cable diameter min</b>	3 mm
<b>Ø cable diameter max</b>	12 mm
<b>External dimensions LxWxH</b>	160 x 140 x 81mm
<b>Using for cable gland</b>	
<b>Product Color</b>	RAL 7035
<b>WISKA-Order no.</b>	10101462
<b>Type</b>	COMBI 1210/5
<b>Packing unit</b>	2
<b>ETIM-Classification</b>	EC002600

Remarks:

IP66: using the membrane entry

IP67: using the threaded entry together with

ESKV cable gland

Mounting: 4 internal openings outside of the sealing area

WISKA Hoppmann & Mulsow GmbH  
 Kisdorfer Weg 28 · 24568 Kaltenkirchen · Germany  
 ☎ +49-4191-508-0 · 📠 +49-4191-508-209  
 contact@wiska.com · www.wiska.com

Equipment: 10 entries M20 with elastic soft membrane and thread and M25 knockout  
4 entries with self-sealing membrane at the bottom (M20)  
4 captive cover screws  
inclusive 5-pole terminal 10mm<sup>2</sup>

03.11.2016



