



## 20A Control Switches



The smooth modern lines of the Deco accessory plate will fit easily into traditional and contemporary designs alike.

Deco 20A Control Switches are designed to fit effortlessly with the range, with simple installation to enhance the décor of any area.

All Deco 20A Control Switches are tested and approved to BS EN 60669 offering assured quality and safety.

20A Control Switches

Product Range

Finish Comparison



Antique Brass (AB)



Polished Brass (BR)



Polished Chrome (CH)



Satin Chrome (SC)



Satin Brass (SB)



Black Nickel (BN)



Pearl Nickel (PN)



Stainless Steel (SS)



Georgian Cast Brass (GCBR)

V1.0

## 20A Control Switches

### Product Range

#### 20A Control Switches

<b>VP**022##</b>	20A Double Pole Switch with Flex Outlet
<b>VP**023##</b>	20A Double Pole Switch with Flex Outlet & Neon
<b>VP**024##</b>	20A Sink & Bath Switch
<b>VP**622##</b>	20A Double Pole Switch
<b>VP**623##</b>	20A Double Pole Switch with Neon



VPSC022WH



VPBN023BK



VPCH024WH



VPSS622BK



VPBR623WH

## 20A Control Switches

### Product Range

#### 'Ingot' 20A Control Switches

**VP\*\*522##**

'Ingot' 20A Double Pole Switch with Flex Outlet

**VP\*\*523##**

'Ingot' 20A Double Pole Switch with Flex Outlet & Neon

**VP\*\*722##**

'Ingot' 20A Double Pole Switch

**VP\*\*723##**

'Ingot' 20A Double Pole Switch with Neon



VPSS522WH



VPAB523BK



VPPN722BK



VPSB723WH

Errors & Omissions excluded. Specification is subject to change without notice. \*\*Denotes Plate Finish, ## Denotes Insert Colour

V1.0

Scolmore International Ltd, 1 Scolmore Park, Landsberg, Lichfield Road Ind. Estate, Tamworth, Staffordshire, B79 7XB

Telephone: 01827 63454

E-mail: [sales@scolmore.com](mailto:sales@scolmore.com), [technical@scolmore.com](mailto:technical@scolmore.com)

Facsimile: 01827 63362

Website: [www.scolmore.com](http://www.scolmore.com)

20A Control Switches

Product Dimensional Drawings (mm)

VP\*\*022, 522

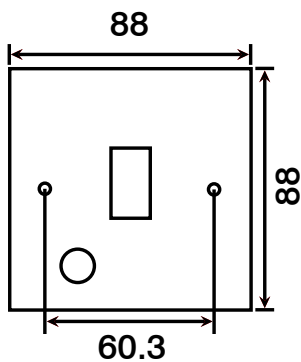

VP\*\*023, 523

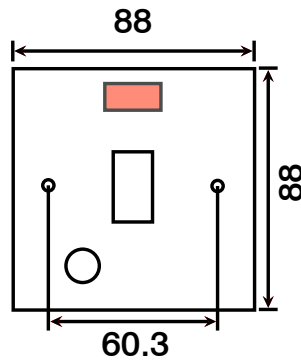

VP\*\*024

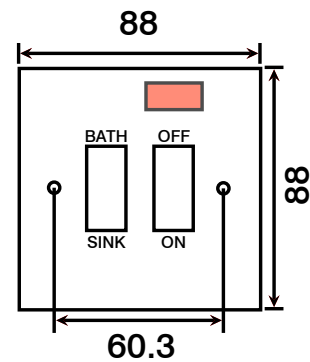

VP\*\*622, 722

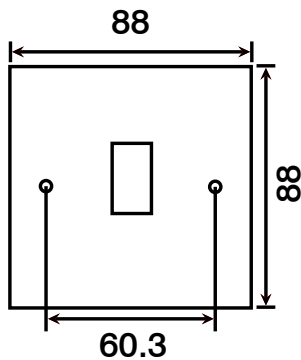

VP\*\*623, 723

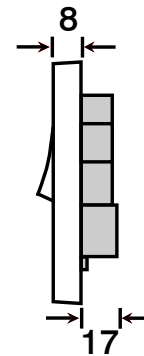
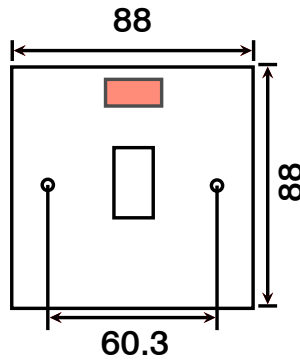

20A Control Switches

Wiring Diagrams

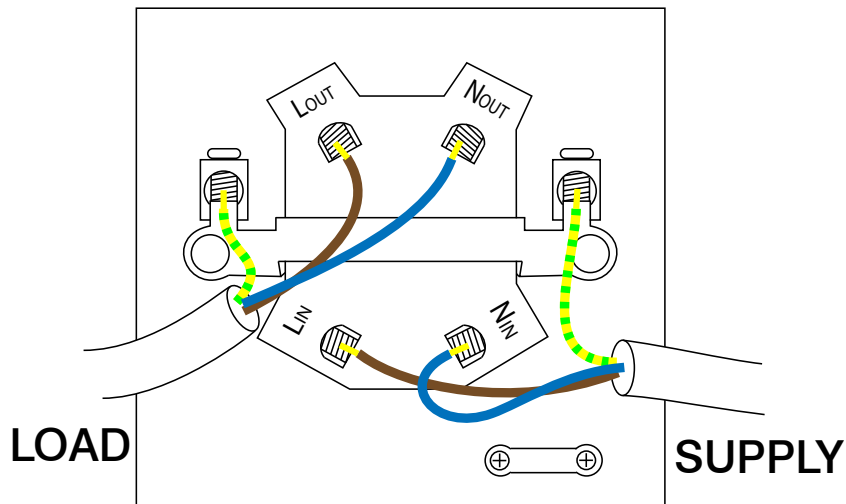

20A Control Switch

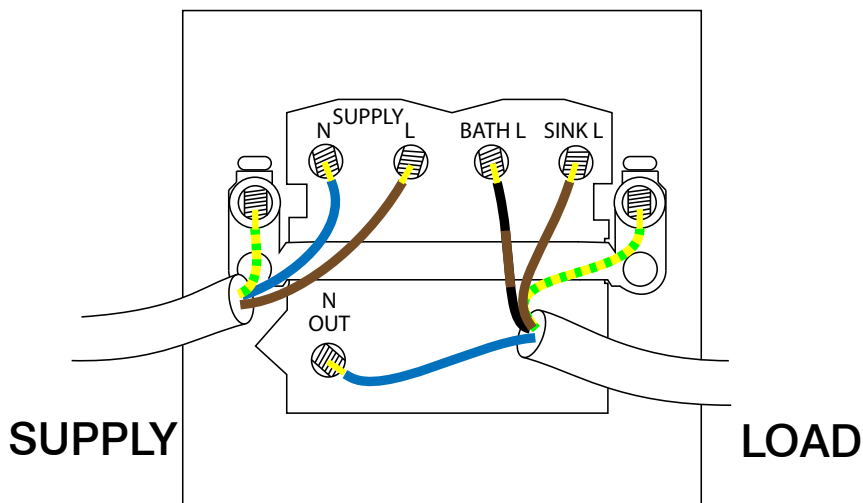

20A Sink Bath Switch

Errors & Omissions excluded. Specification is subject to change without notice.

V1.0

Scolmore International Ltd, 1 Scolmore Park, Landsberg, Lichfield Road Ind. Estate, Tamworth, Staffordshire, B79 7XB

Telephone: 01827 63454

E-mail: sales@scolmore.com, technical@scolmore.com

Facsimile: 01827 63362

Website: www.scolmore.com

## 20A Control Switches

### Technical Specification

#### 20A Control Switches

<b>Material Composition</b>	Front Plate: Stainless Steel
	Rear Housing: Nylon & Urea
	Terminals: Brass
	Earth Strap: Mild Steel
	Terminal Screws: Steel & Yellow Passivated
	Silver “on-lay” Copper / Brass Contacts
<b>Voltage</b>	240V~ 50Hz
<b>Current Rating</b>	20A
<b>Terminal Size</b>	5mm ø
<b>Torque Value</b>	1.8Nm
<b>Cable Size</b>	4 x 2.5mm <sup>2</sup>
<b>Double Pole</b>	Yes
<b>Twin Earth</b>	Yes
<b>Back Box Depth</b>	25mm - 47mm
<b>Warranty</b>	10 Years
<b>IP Rating</b>	IP20
<b>Operational Temperature</b>	-5° to +40°C
<b>Standards</b>	The Low Voltage Directive 2006/95/EC BS EN 60669-1:1999 + A1:2002 + A2:2008

#### Additional Information

Ensure that the mains supply is isolated before commencing installation and refer to the circuit diagram with the relevant product.

Bare earth cables must always be covered with appropriate sleeving and wired to the earth terminal.



DECLARATION OF CONFORMITY

1. *Issuer Name* Scolmore International Limited
2. *Issuer Address* 1 Scolmore Park, Landsberg,  
Lichfield Road Industrial Estate,  
Tamworth, Staffordshire, B79 7XB
3. *Object(s) of Declaration* Deco Range
- a. *Group* 20A Control Switches
- b. *Model No.* VP-022, VP-023, VP-024, VP-522, VP-523, VP-622, VP-623, VP-722, VP-723

4. *The object of the declaration described above is in conformity with the requirements of the following Legislations:*

Document No	Title
2006/95/EC	Low Voltage Directive

5. *All products contained within the aforementioned comply with the relevant standards and requirements listed below.*

EN 60669-1:1999 + A1:2002 + A2:2008

6. *I hereby declare that the equipment named above has been designed to comply with the relevant sections of the above referenced specifications. The unit complies with all applicable Essential Requirements of the Directives.*

*In conjunction with the above all manufacture and process controls are in accordance with ISO 9001:2008*

Signed, for and on behalf of: Scolmore International Limited

Steven Bettson BSc - Senior Technical Support Engineer

**CE 13**