



## 20A Control Switches



The smooth modern lines of the Definity accessory plate will fit easily into traditional and contemporary designs alike.

Definity Screwless 20A Control Switches are designed to fit effortlessly with the range, with simple installation to enhance the décor of any area.

All DEFINITY 20A Control Switches are tested and approved to BS EN 60669 offering assured quality and safety.

**20A Control Switches**

**Product Range**

**Finish Comparison**



Brushed Steel (BS)



Matt Black (BK)

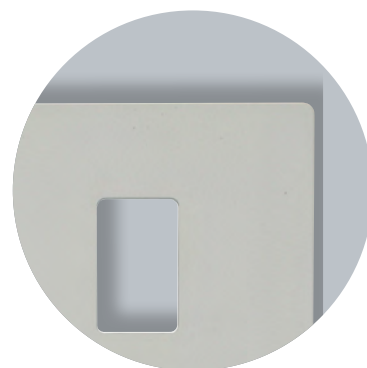

Polar White (PW)



Polished Chrome (CH)



Stainless Steel (SS)

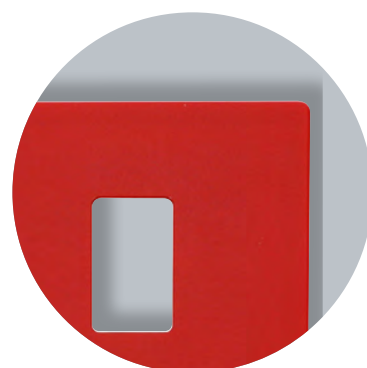

Red (RD)

**20A Control Switches**

**Product Range**

**20A Control Switch Inserts**

<b>SIN022**</b>	20A Double Pole Switch with Flex Outlet Insert
<b>SIN023**</b>	20A Double Pole Switch with Flex Outlet & Neon Insert
<b>SIN024**</b>	20A Sink & Bath Switch With Neon Insert
<b>SIN622**</b>	20A Double Pole Switch Insert
<b>SIN623**</b>	20A Double Pole Switch with Neon Insert



SIN022PW

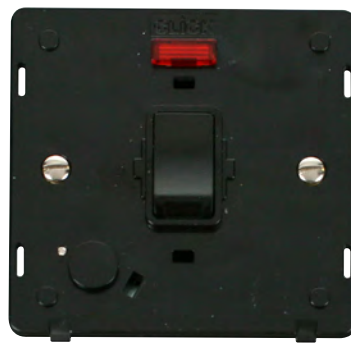

SIN023BK



SIN024PW



SIN622BK



SIN623PW

Errors & Omissions excluded. Specification is subject to change without notice. \*\* Denotes Insert Finish

V1.0

Scolmore International Ltd, 1 Scolmore Park, Landsberg, Lichfield Road Ind. Estate, Tamworth, Staffordshire, B79 7XB

**Telephone:** 01827 63454

**E-mail:** sales@scolmore.com, technical@scolmore.com

**Facsimile:** 01827 63362

**Website:** www.scolmore.com

**20A Control Switches**

**Product Range**

**'Ingot' 20A Control Switch Inserts**

<b>SIN522**##</b>	'Ingot' 20A Double Pole Switch with Flex Outlet Insert
<b>SIN523**##</b>	'Ingot' 20A Double Pole Switch with Flex Outlet & Neon Insert
<b>SIN722**##</b>	'Ingot' 20A Double Pole Switch Insert
<b>SIN723**##</b>	'Ingot' 20A Double Pole Switch with Neon Insert



SIN522PWBS

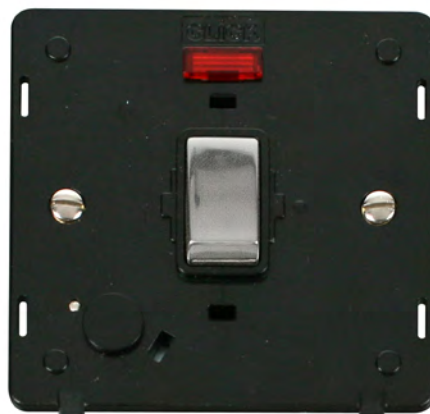

SIN523BKCH

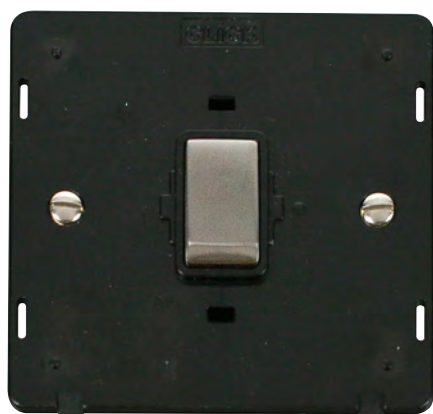

SIN722BKSS



SIN723PWCH

Errors & Omissions excluded. Specification is subject to change without notice. \*\* Denotes Insert Colour, ## Denotes Switch Finish

V1.0

Scolmore International Ltd, 1 Scolmore Park, Landsberg, Lichfield Road Ind. Estate, Tamworth, Staffordshire, B79 7XB

**Telephone:** 01827 63454

**E-mail:** sales@scolmore.com, technical@scolmore.com

**Facsimile:** 01827 63362

**Website:** www.scolmore.com

**20A Control Switches**

**Product Range**

**20A Control Switch Cover Plates**

<b>SCP322**</b>	20A DP Switch With Flex Outlet Cover Plate
<b>SCP323**</b>	20A Double Pole Switch with Flex Outlet & Neon Cover Plate
<b>SCP324**</b>	20A Sink & Bath Switch With Neon Cover Plate
<b>SCP422**</b>	20A Double Pole Switch Cover Plate
<b>SCP423**</b>	20A Double Pole Switch with Neon Cover Plate

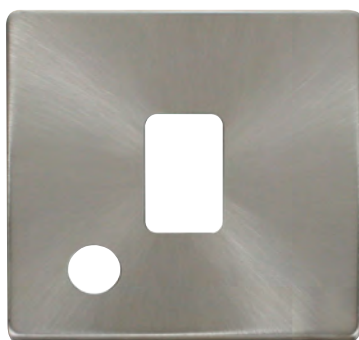

SCP322BS

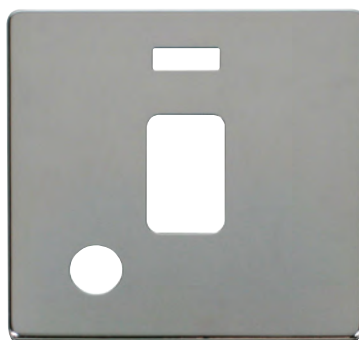

SCP323CH



SCP324BK



SCP422PW



SCP423SS

Errors & Omissions excluded. Specification is subject to change without notice. \*\* Denotes Cover Plate Finish

**20A Control Switches**

**Product Dimensional Drawings (mm)**

SIN022, 522

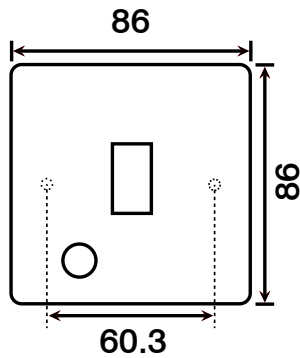

SIN023, 523

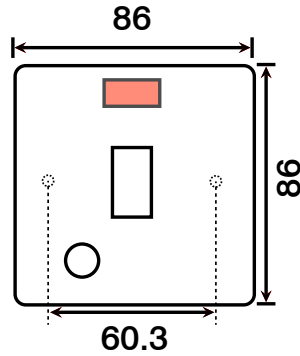

SIN024

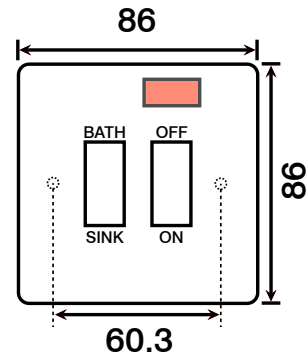

SIN622, 722

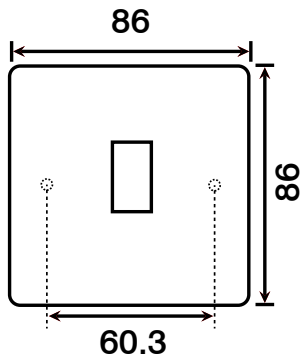

SIN623, 723

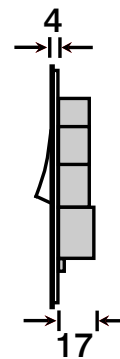
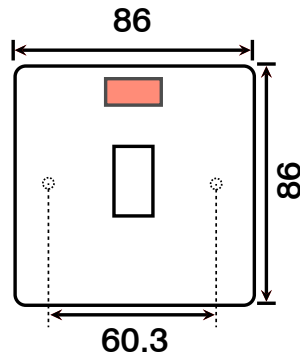



**20A Control Switches**

**Wiring Diagram**

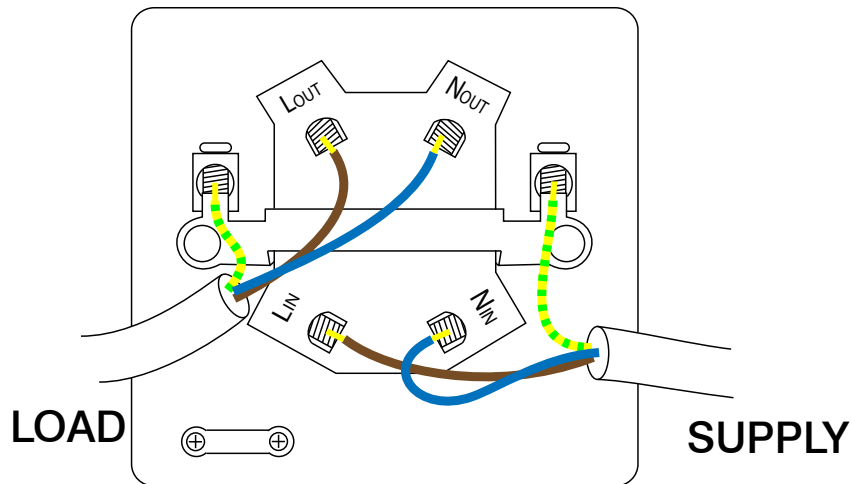

**20A Control Switch**

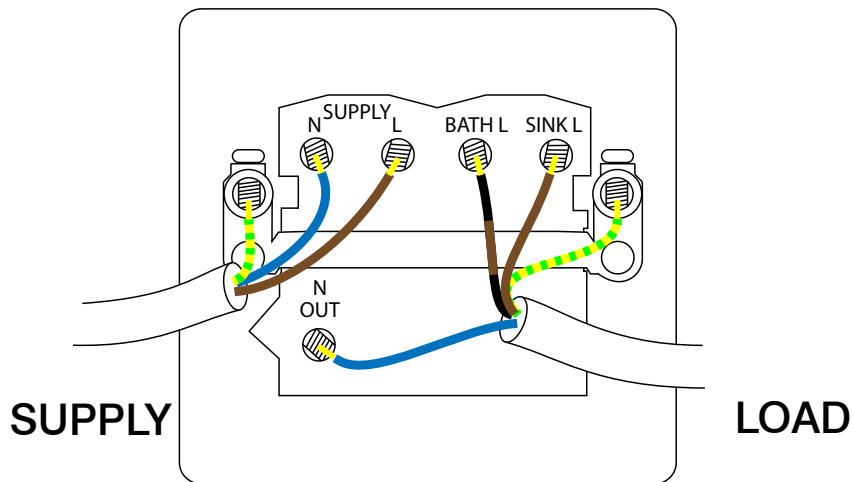

**20A Sink Bath Switch**

Errors & Omissions excluded. Specification is subject to change without notice.

V1.0

Scolmore International Ltd, 1 Scolmore Park, Landsberg, Lichfield Road Ind. Estate, Tamworth, Staffordshire, B79 7XB

**Telephone:** 01827 63454

**E-mail:** sales@scolmore.com, technical@scolmore.com

**Facsimile:** 01827 63362

**Website:** www.scolmore.com

## 20A Control Switches

### Technical Specification

#### 20A Control Switches

<b>Material Composition</b>	Insert: Polycarbonate
	Rear Housing: Nylon & Urea
	Terminals: Brass
	Earth Strap: Mild Steel
	Terminal Screws: Steel & Yellow Passivated
	Silver “on-lay” Copper / Brass Contacts
	Cover Plate: Coated Stainless Steel or Polycarbonate (PW & BK)
<b>Voltage</b>	240V~ 50Hz
<b>Current Rating</b>	20A
<b>Terminal Size</b>	5mm ø
<b>Torque Value</b>	1.8Nm
<b>Cable Size</b>	4 x 2.5mm <sup>2</sup>
<b>Double Pole</b>	Yes
<b>Twin Earth</b>	Yes
<b>Back Box Depth</b>	35mm - 47mm
<b>Warranty</b>	10 Years
<b>IP Rating</b>	IP20
<b>Operational Temperature</b>	-5° to +40°C
<b>Standards</b>	The Low Voltage Directive 2006/95/EC BS EN 60669-1:1999 + A1:2002 + A2:2008

#### Additional Information

Ensure that the mains supply is isolated before commencing installation and refer to the circuit diagram with the relevant product.

Bare earth cables must always be covered with appropriate sleeving and wired to the earth terminal.



## DECLARATION OF CONFORMITY

1. *Issuer Name* Scolmore International Limited
2. *Issuer Address* 1 Scolmore Park, Landsberg,  
Lichfield Road Industrial Estate,  
Tamworth, Staffordshire, B79 7XB
3. *Object(s) of Declaration* Definity Range
- a. *Group* 20A Double Pole Switches
- b. *Model No.* SIN022, SIN023, SIN024, SIN622, SIN623, SIN522, SIN523, SIN722,  
SIN723

4. *The object of the declaration described above is in conformity with the requirements of the following Legislations:*

Document No	Title
2006/95/EC	Low Voltage Directive

5. *All products contained within the aforementioned comply with the relevant standards and requirements listed below.*

EN 60669-1:1999 + A1:2002 + A2:2008

6. *I hereby declare that the equipment named above has been designed to comply with the relevant sections of the above referenced specifications. The unit complies with all applicable Essential Requirements of the Directives.*

*In conjunction with the above all manufacture and process controls are in accordance with ISO 9001:2008*

Signed, for and on behalf of: Scolmore International Limited



Steven Bettson BSc - Senior Technical Support Engineer

# CE 13