



### ***13A Fused Connection Unit Modules***



MINIGRID™ modules are fitted as standard into our moulded POLAR™ & MODE®, decorative DEFINITY™, DEFINE® DECO® and Metal Clad ranges. The MINIGRID™ modules are all easily and quickly exchanged or mounted onto unfurnished plates by means of a simple single screw fixing.

**13A Fused Connection Unit Modules**

**Product Range**

**Finish Comparison**



Antique Brass (AB)

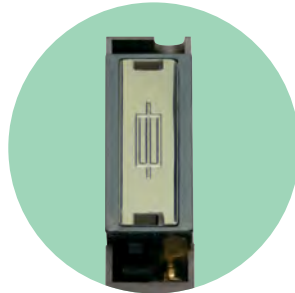

Polished Brass (BR)



Polished Chrome (CH)



Click White (WH)

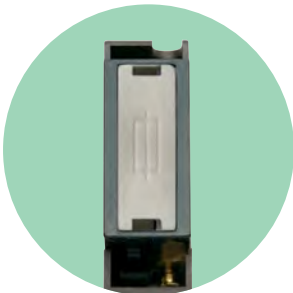

Satin Chrome (SC)



Satin Brass (SB)



Black Nickel (BN)

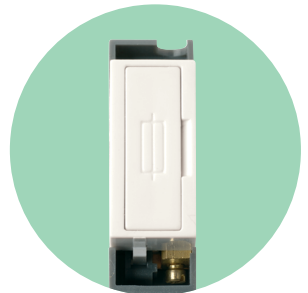

Polar White (PW)

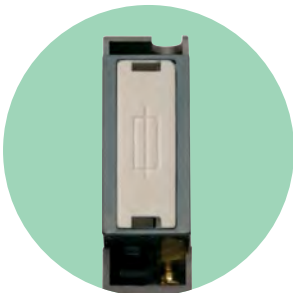

Pearl Nickel (PN)



Stainless Steel (SS)



Brushed Steel (BS)

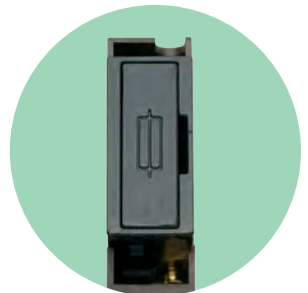

Black (BK)

Errors & Omissions excluded. Specification is subject to change without notice.

V1.0

Scolmore International Ltd, 1 Scolmore Park, Landsberg, Lichfield Road Ind. Estate, Tamworth, Staffordshire, B79 7XB

**Telephone:** 01827 63454

**E-mail:** sales@scolmore.com, technical@scolmore.com

**Facsimile:** 01827 63362

**Website:** www.scolmore.com

**13A Fused Connection Unit Modules**

**Product Range**

**13A Fused Connection Unit Modules**

**MD047##\*\***

13A Fused Connection Unit Module



MD047PW

**Product Dimensional Drawings (mm)**

MD047

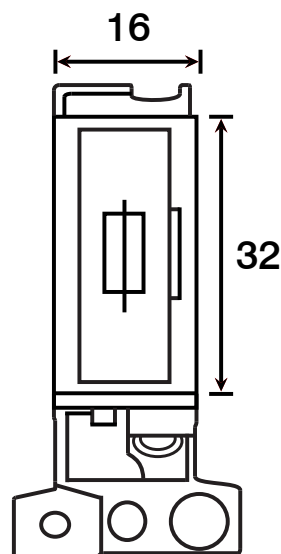

Errors & Omissions excluded. Specification is subject to change without notice. ## Denotes Insert Colour, \*\* Denotes Module Finish

**13A Fused Connection Unit Modules**

**Wiring Diagrams**

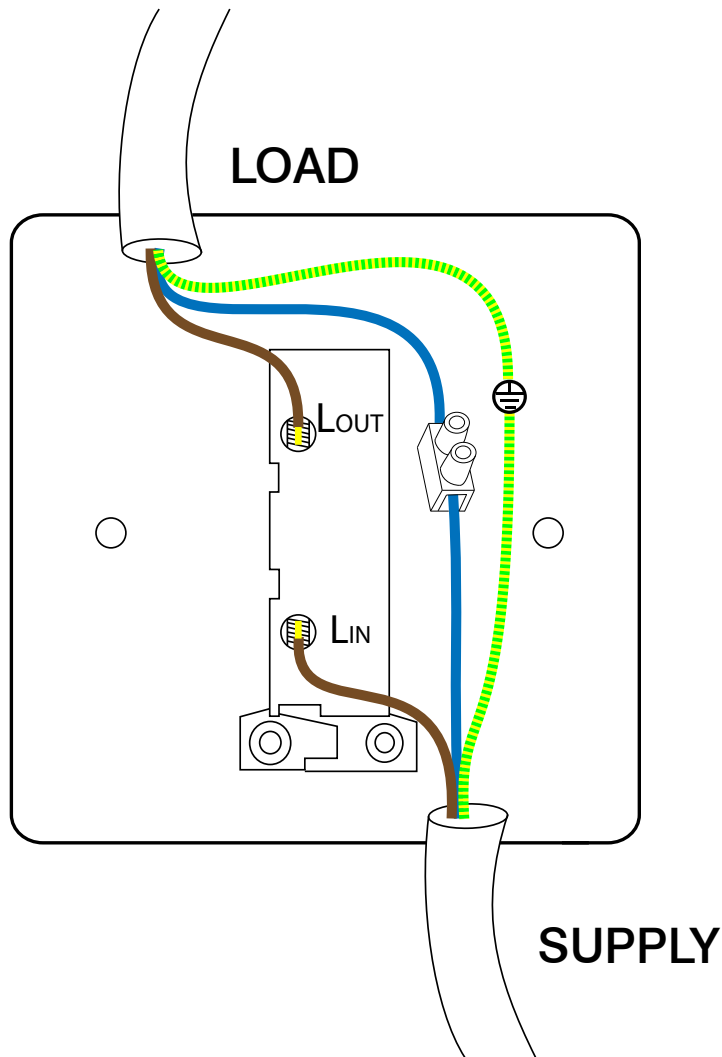

## 13A Fused Connection Unit Modules

### Technical Specification

#### 13A Fused Connection Unit Modules

<b>Material Composition</b>	Module Front: Urea or Urea + Stainless Steel Cover (Ingot) Rear Housing: Nylon Terminals: Brass Terminal Screws: Steel & Yellow Passivated
<b>Voltage</b>	240V~ 50Hz
<b>Current Rating</b>	13A
<b>Terminal Size</b>	3.5mm ø
<b>Torque Value</b>	0.8Nm
<b>Cable Size</b>	4 x 1.5mm <sup>2</sup> or 2 x 2.5mm <sup>2</sup>
<b>Back Box Depth</b>	16mm - 47mm (Dependant on Mounting Plate Used)
<b>Modular</b>	Yes
<b>Warranty</b>	10 Years
<b>Anti Microbial Certified</b>	Yes (Non Ingot Switches Only)
<b>IP Rating</b>	IP20
<b>Operational Temperature</b>	-5° to +40°C
<b>Standards</b>	The Low Voltage Directive 2006/95/EC BS 5733:1995 Modified ISO 22196

### Additional Information

Ensure that the mains supply is isolated before commencing installation.

Bare earth cables must always be covered with appropriate sleeving and wired to the earth terminal.

All white moulded accessories are manufactured using Urea Formaldehyde, which has similar inherent properties to antimicrobial additives that inhibit the growth of infectious diseases. All products were independently tested and achieved a 99.9% kill rate across all four types of the strains of bacteria - MRSA, E-Coli, Salmonella, and Klebsiella Pneumoniae.



DECLARATION OF CONFORMITY

- 1. *Issuer Name* Scolmore International Limited
- 2. *Issuer Address* 1 Scolmore Park, Landsberg,  
Lichfield Road Industrial Estate,  
Tamworth, Staffordshire, B79 7XB
- 3. *Object(s) of Declaration* MINIGRID Range
  - a. *Group* 13A Fused Connection Unit Modules
  - b. *Model No.* MD047
- 4. *The object of the declaration described above is in conformity with the requirements of the following Legislations:*

Document No	Title
2006/95/EC	Low Voltage Directive

5. *All products contained within the aforementioned comply with the relevant standards and requirements listed below.*

*BS 5733 : 1995*

6. *I hereby declare that the equipment named above has been designed to comply with the relevant sections of the above referenced specifications. The unit complies with all applicable Essential Requirements of the Directives.*

*In conjunction with the above all manufacture and process controls are in accordance with ISO 9001:2008*

Signed, for and on behalf of: Scolmore International Limited

Steven Bettson BSc - Senior Technical Support Engineer

