

Product Code: CU1RCBO40B

Description: 1 Pole True 6kA B Curve 40A 30mA RCBO

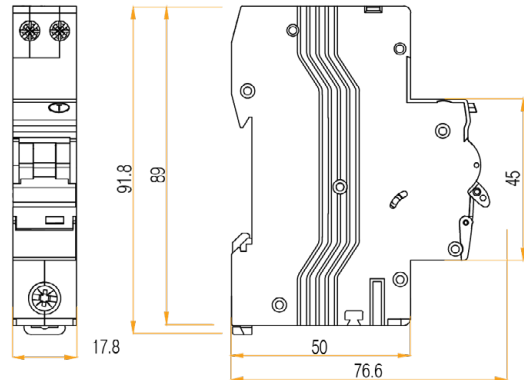

**General Information**

<b>Overall Dimensions</b>	17.8mm (W) x 91.8mm (H) x 76.6mm (D)	
<b>Finish</b>	Light Grey (RAL 7035)	
<b>Rated Operational Voltage (U<sub>a</sub>)</b>	240V~ 50/60Hz	
<b>Maximum Rated Current (I<sub>n</sub>)</b>	40A	
<b>RCD Type</b>	A	
<b>MCB Operating Characteristics</b>	B Curve	
<b>Neutral Tail Length</b>	450mm	
<b>Rated Breaking Capacity (I<sub>cs</sub>)</b>	True 6kA	
<b>Number Of Poles</b>	1P + N	
<b>Impulse Withstand Voltage (U<sub>imp</sub>)</b>	4000V	
<b>Endurance Operations</b>	Mechanical: 20000	Electrical: 5000
<b>Residual Current Making &amp; Breaking Capacity (I<sub>m</sub>)</b>	500A	
<b>Tripping Current</b>	30mA	
<b>Residual Non-operating Current (I<sub>Δn</sub>)</b>	0.5	
<b>Trip Type</b>	Earth Fault: Electronic/Electromagnetic Over Current: Thermal/Magnetic	
<b>Device Terminal Type</b>	Screwed Lug & Pin	
<b>Input Terminal Capacity</b>	25mm <sup>2</sup> Flexible / 32mm <sup>2</sup> Rigid	
<b>Output Terminal Capacity</b>	16mm <sup>2</sup> Flexible / 25mm <sup>2</sup> Rigid	
<b>Maximum Torque</b>	Input: 2.0Nm	Output: 1.2Nm
<b>Operational Temperature</b>	-25°C to +40°C	
<b>Ingress Protection</b>	IP20	
<b>Warranty</b>	3 Years	

**Standards** BS EN 61009-1

