

Product Code: CU1RCBO10B

Description: 1 Pole True 6kA B Curve 10A 30mA RCBO

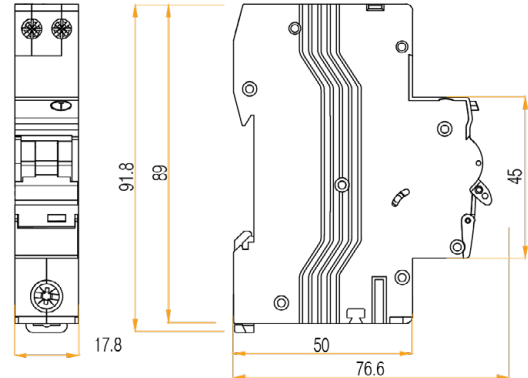

General Information

Overall Dimensions	17.8mm (W) x 91.8mm (H) x 76.6mm (D)	
Finish	Light Grey (RAL 7035)	
Rated Operational Voltage (U_a)	240V~ 50/60Hz	
Maximum Rated Current (I_n)	10A	
RCD Type	A	
MCB Operating Characteristics	B Curve	
Neutral Tail Length	450mm	
Rated Breaking Capacity (I_{cs})	True 6kA	
Number Of Poles	1P + N	
Impulse Withstand Voltage (U_{imp})	4000V	
Endurance Operations	Mechanical: 20000	Electrical: 5000
Residual Current Making & Breaking Capacity (I_m)	500A	
Tripping Current	30mA	
Residual Non-operating Current (I_{Δn})	0.5	
Trip Type	Earth Fault: Electronic/Electromagnetic Over Current: Thermal/Magnetic	
Device Terminal Type	Screwed Lug & Pin	
Input Terminal Capacity	25mm ² Flexible / 32mm ² Rigid	
Output Terminal Capacity	16mm ² Flexible / 25mm ² Rigid	
Maximum Torque	Input: 2.0Nm	Output: 1.2Nm
Operational Temperature	-25°C to +40°C	
Ingress Protection	IP20	
Warranty	3 Years	

Standards BS EN 61009-1

