

Product Code: CU1MCB63B

Description: 1 Pole True 6kA B Curve 63A MCB

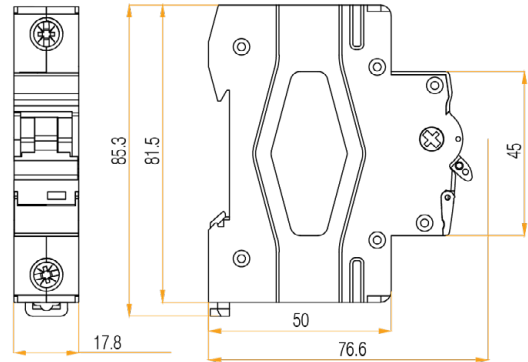

General Information

Overall Dimensions	17.8mm (W) x 85.3mm (H) x 76.6mm (D)	
Finish	Light Grey (RAL 7035)	
Rated Operational Voltage (U_e)	230V/400V~ 50/60Hz	
Thermal Operating Limit	(1.13-1.45) x I _n	
Maximum Rated Current (I_n)	63A	
MCB Operating Characteristics	B Curve	
Rated Breaking Capacity (I_{cs})	True 6kA	
Number Of Poles	1	
Insulation Voltage (U_i)	500V	
Impulse Withstand Voltage (U_{imp})	4000V	
Endurance Operations	Mechanical: 20000	Electrical: 8000
Trip Type	Thermal/Magnetic Release	
Operating Characteristics	(3-5) x I _n	
Device Terminal Type	Screwed Lug & Pin	
Terminal Capacity	25mm ² Flexible or 35mm ² Rigid	
Maximum Torque	2.0Nm	
Operational Temperature	-5°C to +40°C	
Ingress Protection	IP20	
Warranty	3 Years	

Standards BS EN 60898-1

