

Product Code: CU1MCB32B

Description: 1 Pole True 6kA B Curve 32A MCB

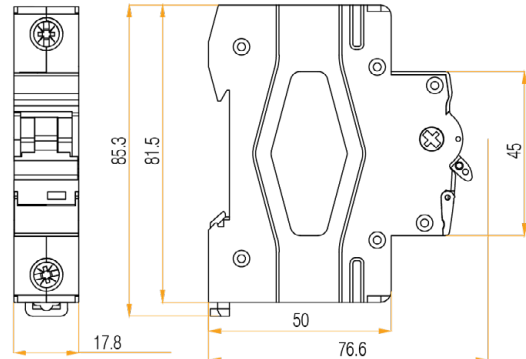

**General Information**

<b>Overall Dimensions</b>	17.8mm (W) x 85.3mm (H) x 76.6mm (D)	
<b>Finish</b>	Light Grey (RAL 7035)	
<b>Rated Operational Voltage (U<sub>e</sub>)</b>	230V/400V~ 50/60Hz	
<b>Thermal Operating Limit</b>	(1.13-1.45) x I <sub>n</sub>	
<b>Maximum Rated Current (I<sub>n</sub>)</b>	32A	
<b>MCB Operating Characteristics</b>	B Curve	
<b>Rated Breaking Capacity (I<sub>cs</sub>)</b>	True 6kA	
<b>Number Of Poles</b>	1	
<b>Insulation Voltage (U<sub>i</sub>)</b>	500V	
<b>Impulse Withstand Voltage (U<sub>imp</sub>)</b>	4000V	
<b>Endurance Operations</b>	Mechanical: 20000	Electrical: 8000
<b>Trip Type</b>	Thermal/Magnetic Release	
<b>Operating Characteristics</b>	(3-5) x I <sub>n</sub>	
<b>Device Terminal Type</b>	Screwed Lug & Pin	
<b>Terminal Capacity</b>	25mm <sup>2</sup> Flexible or 35mm <sup>2</sup> Rigid	
<b>Maximum Torque</b>	2.0Nm	
<b>Operational Temperature</b>	-5°C to +40°C	
<b>Ingress Protection</b>	IP20	
<b>Warranty</b>	3 Years	

**Standards** BS EN 60898-1

