

ACCESSORIES

Technical Specification

Product Code: OVCG24V30IP20L

Description: 30W 24V Constant Voltage LED Driver – Linear

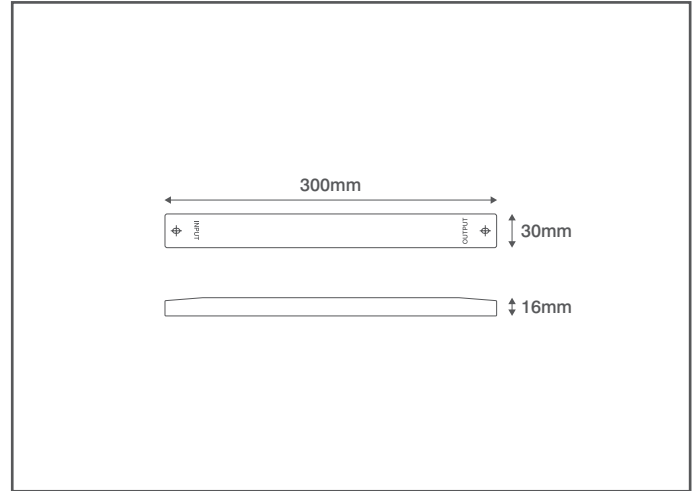
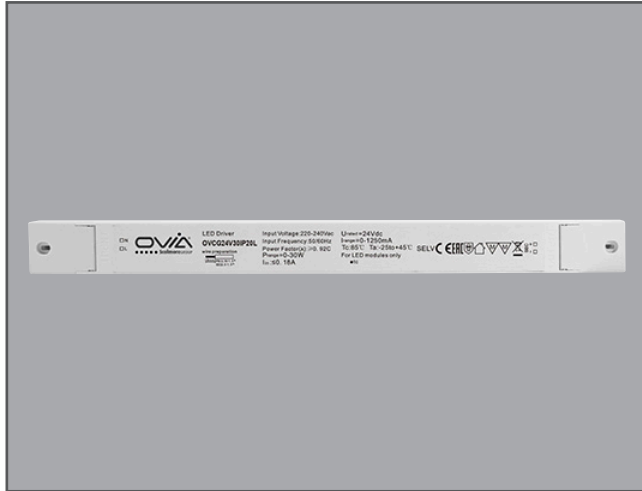

General Information

Dimensions	300mm (L) x 30mm (W) x 16mm (D)
Materials	Housing: Polycarbonate
Finish	White
Product Weight	0.18Kg
Dimmable	No
Ingress Protection	IP20
Warranty	5 Years

Supply & Power

Input Voltage & Frequency	220-240V~ 50/60Hz
Electrical Safety	Class II (Double Insulated)
Rated Power	30W Max.
Ambient Temperature (Ta)	-25°C - +45°C
Critical Temperature	+85°C
Cable Size	0.75mm ² -1.5mm ² (Input)
Input Terminations	Screw Terminals

Input Information

Input Current	≤21mA
Input Power	<36W
Power Factor	≥0.92
16A Circuit Breaker	Type B: 5
Inrush Current	50A/ <0.5mS

Output Information

Output Voltage	24V DC
Output Current	0-1250mA
Output Power (Max.)	30W
Efficiency	≥85%

Protection

Short Circuit Protection	Auto Recovery
Overload Protection	Auto Recovery
No Load Protection	Auto Recovery
Insulation Voltage	3.75KVAC/5mA/60S Primary to Secondary
Insulation Resistance	>4M Ohm @ 500V DC
Leakage Current	<0.7mA, Primary to Secondary @240V~
Flicker Free	Yes



Ovia Limited, Scolmore House, Mariner, Lichfield Road Industrial Estate, Tamworth, Staffordshire, B79 7UL United Kingdom

T: +44 (0)1827 300640

E: sales@oviaUK.com | W: oviaUK.com