

Product Code: OV80122MWEM

Description: 41W 1200mm Linear Utility LED Light With Microwave & Emergency - IP65

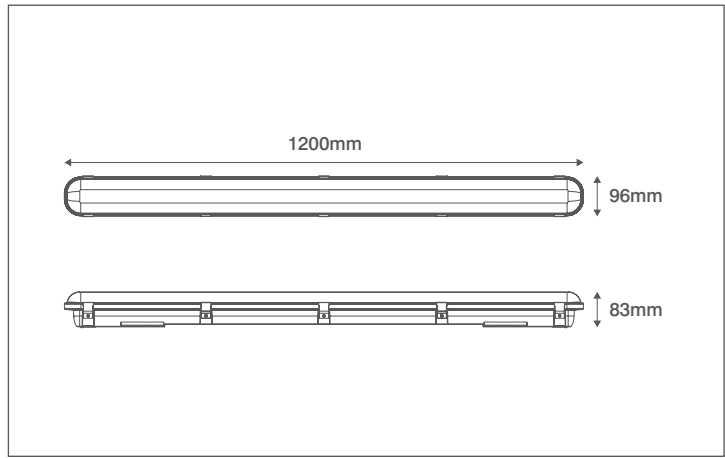

General Information

Dimensions	1200mm (L) x 96mm (W) x 83mm (D)
Materials	Base: Polycarbonate Frosted Diffuser: Polycarbonate
Base Finish	Light Grey
Product Weight	1.91Kg
Dimmable	No
Ingress Protection	IP65
IK Rating	IK08
Mounting	Ceiling, Wall or Suspended
Warranty	5 Years

Supply & Power

Input Voltage & Frequency	220-240V~ 50/60Hz
Electrical Safety	Class I
Input Power	41W
Input Current	205mA
Inrush Current	4A (302ms)
Power Factor	> 0.9
Ambient Temperature (Ta)	0°C - +40°C
Critical Temperature	+90°C
Terminations	5 Pole Push Fit Terminal Block
Cable Input Component	20mm IP68 Nylon Gland Supplied
Fixing Components	Surface and Suspension Brackets Supplied

Accessories

OVEMB6430LIS	6.4V 3000mAh LiFePo4 Serial Battery - Serial
--------------	--

Luminaire Output

Colour Temperature	4000K
CRI	> 80
Typical Luminous Flux	4680lm
Efficacy	114lm/W
Beam Angle	105°
LED Lifetime (L70)	50,000 Hours
Fixing Components	Surface and Suspension Brackets Supplied

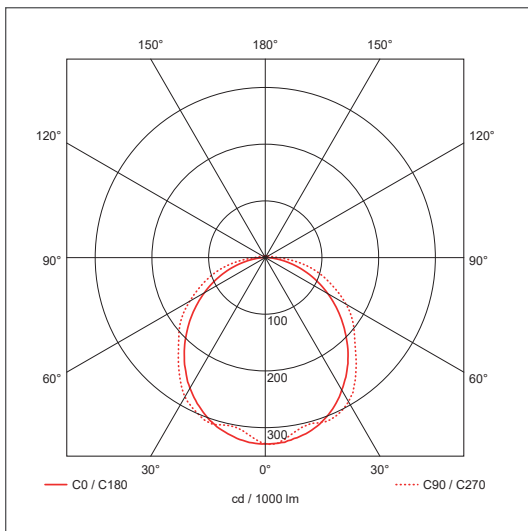

Microwave Information

Mounting Height	6M (Ceiling), 3M (Wall) (Recommended)
Detection Angle	30° - 150°
Detection Range	14M (Ceiling), 10M (Wall)
Detection Area	10% / 50% / 75% / 100% (DIP Switch Setting)
Hold Time	5s / 90s / 5min. 15min. (DIP Switch Setting)
Daylight Threshold	2Lux / 10Lux / 50Lux / Disable (DIP Switch Setting)
HF System	5.8GHz ± 75MHz

Emergency Information

Installation Requirements	Wired as maintained and controlled using the microwave sensor
Battery Specification	6.4V 3000mAh LiFePo4
Emergency Duration	3 Hours Minimum
Battery Warranty	4 Years
Emergency Light Level	400lm

