

Technical Specification

Product Code: OV6412

Description: 12W 165mm Diameter Adaptable Downlight With CTA Switch - White

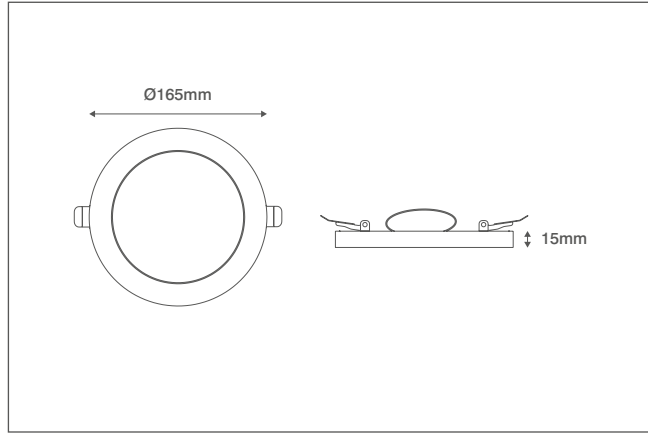
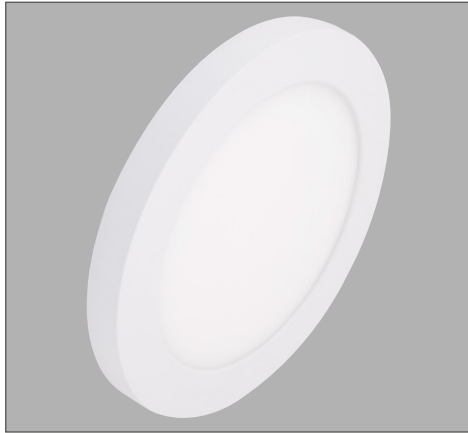

General Information

Dimensions	165mm Diameter x 15mm (D)
Materials	Body: Polycarbonate Diffuser: Polystyrene
Finish	White (RAL 9016)
Product Weight	0.264Kg
Cutout (If Available)	55-125mm Diameter
Ingress Protection	IP20
Warranty	3 Years

Supply & Power

Input Voltage & Frequency	240V~ 50/60Hz
Electrical Safety	Class II (Double Insulated)
Input Power	12W
Input Current	100mA
In-rush Current	2A (10ms)
Power Factor	>0.5
Ambient Temperature (Ta)	-20°C - +40°C
Critical Temperature	+50°C
LED Driver	Integrated
Input Mains Cable	2 x 0.75mm ² H03-VH2F (150mm)

Luminaire Output

Colour Temperature	3000K	4000K	6000K
Typical Luminous Flux	993lm	1035lm	992lm
Efficacy	82lm/W	86lm/W	82lm/W
CRI	>80		
Beam Angle	110°		
Flicker Free	Yes		
LED Lifetime (L70)	30,000 Hours		

Accessories

OVBZ6412SC	Fascia Ring For 12W Downlight - Satin Chrome
OVBZ6412CH	Fascia Ring For 12W Downlight - Chrome
OVBZ6412BK	Fascia Ring For 12W Downlight - Black

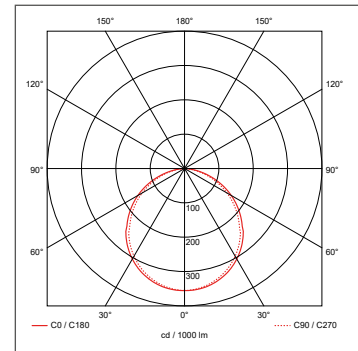

3000K

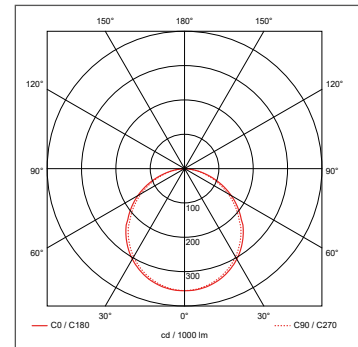

4000K

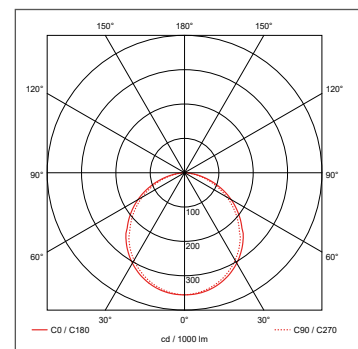

6000K

