

ALUPANEL

Technical Specification

Product Code: OV6209CW

Description: 9W 150mm Diameter LED Downlight – IP44 - 4000K - White

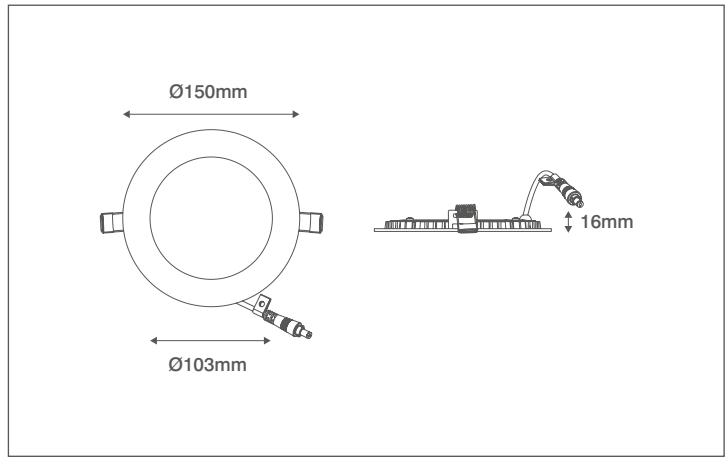
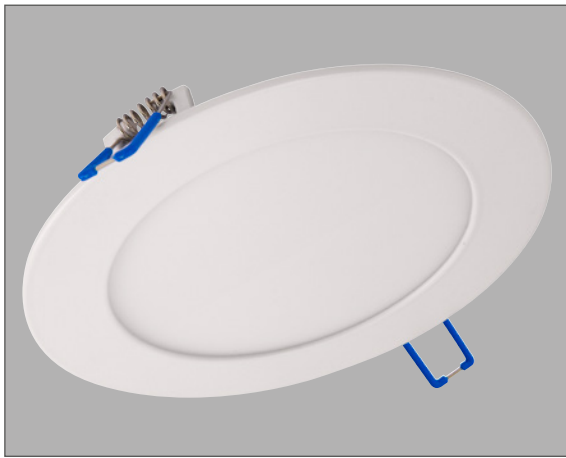

General Information

Dimensions	150mm Diameter x 20.5mm (D)
Materials	Body: Powdercoated Aluminium Diffuser: Polystyrene Light Guide Plate (LGP): Polystyrene
Finish	White (RAL 9003)
Product Weight	0.21Kg
Cutout	130mm Diameter
Ingress Protection	IP44
Ceiling Thickness	32mm Max.
Warranty	2 Years

Supply & Power

Input Voltage & Frequency	230V~ 50/60Hz
Electrical Safety	Class II (Double Insulated)
Input Power	9W
Input Current	280mA
Inrush Current	1.5A (<5ms)
Power Factor	>0.5
Ambient Temperature (Ta)	-20°C - +40°C
Critical Temperature	+45°C
LED Driver	Remote Driver Supplied
Prewired Flow™ Connector	Yes (3 Pole CT105-F Push-fit Terminals)

Accessories

OVEMCG50 | 3 Hour Emergency Pack

Luminaire Output

Colour Temperature	4000K
CRI	>80
Typical Luminous Flux	600lm
Efficacy	67lm/W
Beam Angle	120°
LED Lifetime (L70)	20,000 Hours

