

Product Code: OV6106CW

Description: 6W 116mm Diameter LED Downlight - 4000K - White

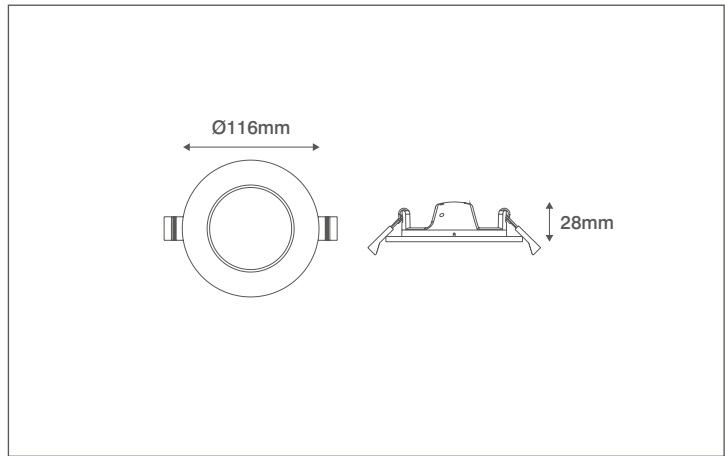

General Information

Dimensions	116mm Diameter x 28mm (D)
Materials	Body: Polycarbonate + ABS
	Diffuser: Polystyrene
	Light Guide Plate (LGP): Polystyrene
Finish	White (RAL 9016)
Product Weight	0.127Kg
Cutout	100mm Diameter
Ingress Protection	IP20
Ceiling Thickness	20mm Max.
Warranty	2 Years

Supply & Power

Input Voltage & Frequency	220-240V~ 50/60Hz
Electrical Safety	Class II (Double Insulated)
Input Power	6W
Input Current	50±10mA
Power Factor	>0.5
Ambient Temperature (Ta)	-10°C - +40°C
Critical Temperature	+85°C
LED Driver	Integrated
Termination	Terminal Block (Screw Terminals)

Luminaire Output

Colour Temperature	4000K
CRI	>80
Typical Luminous Flux	390lm
Efficacy	65lm/W
Beam Angle	110°
LED Lifetime (L70)	30,000 Hours

