



Product Instruction Manual

# Accona



**AN500T, AN1000, AN1000T,  
AN1500, AN1500T  
AN2000, AN2000T**

Panel heater

# Contents

1. Important safety points
2. Installation
  - 2.1. Wall mounting
  - 2.2. Electrical
3. Operation - Non-timer models
4. Operation – 7-day timer models
  - 4.1 How to set the date and time on your heater
  - 4.2 Setting the target temperatures
  - 4.3 Selecting a pre-loaded schedule
  - 4.4 Programming your own customised schedule
5. Advanced features (7-day timer models)
  - 5.1 Copy and paste programming
  - 5.2 Activating the child lock
  - 5.3 Centigrade / Fahrenheit display
  - 5.4 Delayed start and shut down mode
6. Maintenance
7. Specifications
8. Guarantee and service policy

Thank you for purchasing a Hyco Accona panel heater. The Accona is ideal for a wide range of fixed installation heating applications in the home and office environment. The Accona panel heater is available in 4 power outputs and with 7-day LCD timer and non-timer options (the 0.5kW model is available in timer version only). Please read and understand these instructions before commencing installation and leave them with the user when installation is complete.

## 1. Important safety points



The Electrical installation must be carried out by a qualified electrician in accordance with the current edition of the I.E.E. Wiring Regulations.



Only connect the unit to a single phase supply with a mains voltage as specified on the rating plate.



The supply cord cannot be replaced by the user. If the cord is damaged the appliance should be returned to the manufacturer or an authorised service agent for replacement.



Do not carry the appliance by the power cord.



Do not let the power cord hang over the appliance.



The heater must not be located immediately below or above an electrical socket outlet.



This appliance can be used by children aged from 8 years and above and persons with reduced physical, sensory or mental capabilities or lack of experience and knowledge if they have been given supervision or instruction concerning use of the appliance in a safe way and understand the hazards involved.



Children of less than 3 years should be kept away unless continuously supervised. Children aged from 3 years and less than 8 years shall only switch on/off the appliance provided that it has been placed or installed in its intended normal operating position and they have been given supervision or instruction concerning use of the appliance in a safe way and understand the hazards involved. Children aged from 3 years and less than 8 years shall not plug in, regulate and clean the appliance or perform user maintenance.



Some parts of this product can become very hot and cause burns. Particular attention has to be given where children and vulnerable people are present.



Only use the mounting bracket supplied and do not modify the bracket.



In order to avoid overheating, do not cover the heater.



Fixed heaters likely to be used in bathrooms are to be installed so that switches and other controls cannot be touched by a person in the bath or shower.

## 2. Installation

### Wall Mounting



The heater must not be located immediately below or above an electrical socket outlet.



Only use the mounting bracket supplied and do not modify the bracket.



Fixed heaters likely to be used in bathrooms are to be installed so that switches and other controls cannot be touched by a person in the bath or shower.

#### Step 1:

Choose a suitable location for the mounting of the heater ensuring that the surface will be strong enough to hold the weight of the product. The heater must not be mounted closer than 150mm to any horizontal or vertical surface, as detailed in figure 1.

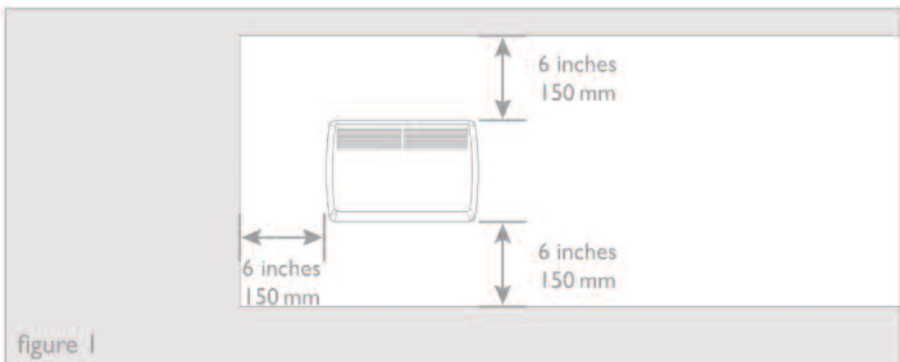

*Step 2:*

Hold the bracket up against the mounting surface, ensuring it is horizontal, and mark the outer holes through the bracket onto the surface of the mounting wall. Drill and fit wall plugs and then fix the bracket to the mounting surface.

*Step 3:*

Offer up the heater to the bracket and attach as per figure 2. Fasten the clips and verify heater is securely fixed to the wall.

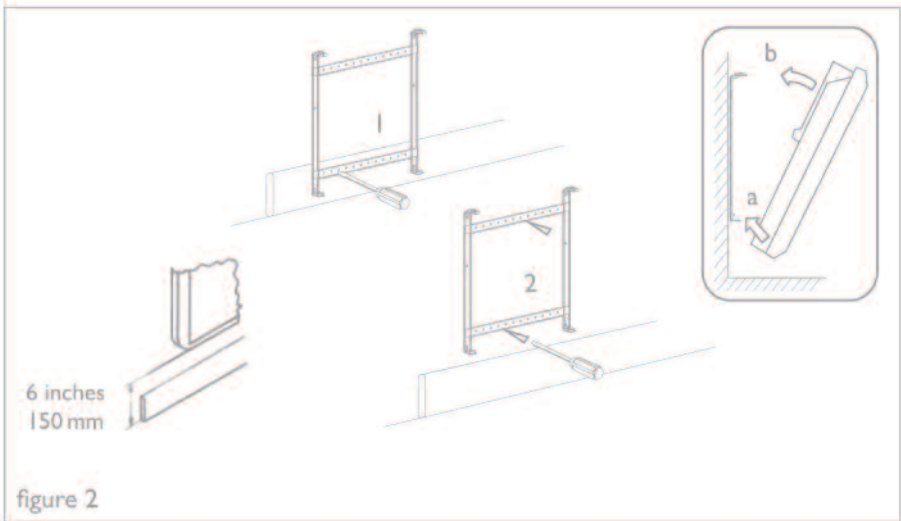

## Electrical

The Electrical installation must be carried out by a qualified electrician in accordance with the current edition of the I.E.E. Wiring Regulations.

Only connect the unit to a single phase supply with a mains voltage as specified on the rating plate.

If the heater is to be connected to the fixed wiring of the property then installation must include a double pole isolating switch with a break contact distance of at least 3mm.

The power cord should be connected following the colour coding below:

- > Brown: L
- > Blue: N
- > Green / Yellow: E

### 3. Operation: non timer models (AN1000, AN1500 & AN2000)

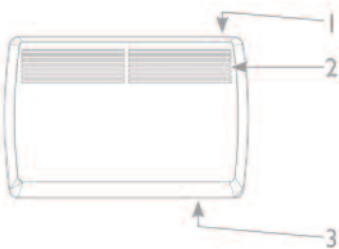

1. Control Unit
2. Air Outlet
3. Air Inlet

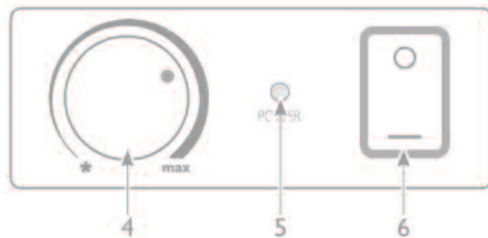

4. Temperature Control Knob
5. Power Indicator
6. Switch (ON: - OFF: O)

- Turn the power switch to the on (-) position.
- Adjust the thermostat to the desired temperature.

## 4. Operation: 7-day timer models (AN500T, AN1000T, AN1500T & AN2000T)

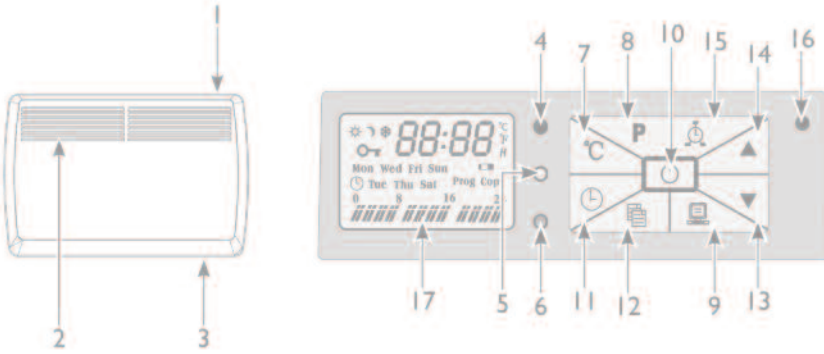

- |   |                                  |
|---|----------------------------------|
| 1. Control Unit                           | 10. Standby Button               |
| 2. Air Outlet                             | 11. Date and Time Setting Button |
| 3. Air Inlet                              | 12. Copy and Paste Button        |
| 4. Red 'Peak' Temperature Indicator       | 13. Down Select Button           |
| 5. Yellow Element 'On' Button             | 14. Up Select Button             |
| 6. Green 'Off Peak' Temperature Indicator | 15. Timer On/Off Button          |
| 7. Temperature Setting Button             | 16. On/Off Indicator             |
| 8. Program Select Button                  | 17. LCD Display                  |
| 9. User Program Setting Button            |                                  |

### 4.1 How to set the date and time on your heater

The below example illustrates how to set the clock to Thursday 3.03PM.

#### Step 1:

Press the clock icon once, this will cause the day of the week to start flashing.



#### Step 2:

Use the up/down icons to cycle through the days. In this example the up button has been pressed three times selecting Thursday.



*Step 3:*

Press the clock icon again and this will store the day as well as highlight the next field which is the hour of the day.



*Step 4:*

Use the up/down icons to cycle through the hours, in this example we will press the up button three times in order to display 15:00



*Step 5:*

Press the clock icon to save the hour setting and move on to the minutes setting.



*Step 6:*

Use the up/down icon to cycle through the minutes, in this example we will press the up button three times in order to select 15:03.



*Step 7:*

Press the clock to finalise the time.



## 4.2 Setting the target temperatures

The thermostat settings can only be set whilst the unit is turned on (not standby). Unlike many panel heaters the Accona timer range utilises two temperature ranges. The first is the temperature the heater will maintain during the 'Peak' setting and the second is the 'Off peak' setting.

Peak  : When you want a 'comfortable' temperature whilst occupying the room in which the heater is located. This can be as high as 30°C.

Off Peak  : The Off peak (typically night time) temperature setting ensures the room will not fall below a user chosen temperature. This can be as low as 5°C (frost protection) and must be a few degrees cooler than the Peak temperature setting.



*Step 1:*

Press the °C icon to enter the 'Peak' temperature setting mode. When selected correctly it will be indicated by the flashing ⚙ symbol.



*Step 2:*

To alter the target temperature, press the up/down icon the desired number of times. In this example the up icon had been pressed three times to increase the set point from 22°C to 25°C.



*Step 3:*

Press the °C icon to store the 'Peak' temperature and also move onto the 'Off peak' setting. 'Off peak' is indicated by the ☾ symbol which will flash when selected.

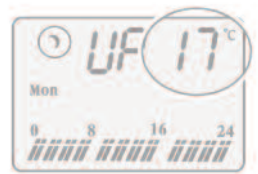

*Step 4:*

As with step 2 it is possible to alter the target temperature for the 'Off peak' mode by simply pressing the up/down symbols the desired number of times. In this example the down icon has been pressed three times to change the target temperature from 17°C to 14°C.

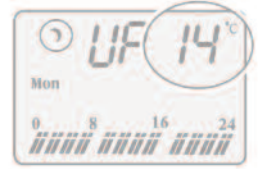

*Step 5:*

To store the 'Off peak' setting simply press the °C icon once. The display will now return to the current room temperature display.





The pre-loaded schedules that are available are defined in the previous table.

**If you wish to have the unit operate in non-timer style you should select pre-set 'CC' to switch the heater on/off press the  button.**

Study the available pre-sets to decide which setting is best suited to the requirements.

*Step 1:*

Press the **P** icon to enter the schedule selection mode. This will cause the current selected pre-set to flash. Upon first operation the default pre-set is 'CC'.

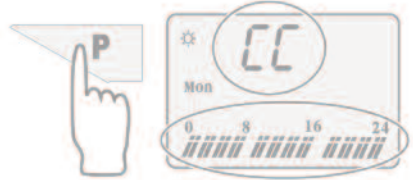

*Step 2:*

Press the up/down icon until the desired schedule is displayed. We have a selected P2 as our schedule.

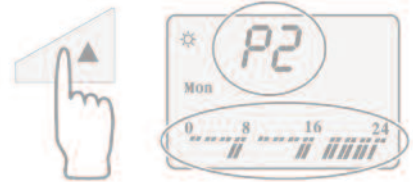

*Step 3:*

Once the desired schedule is selected, press the **P** icon to store and run this setting. The display will now show the selected schedule.





#### 4.4 Programming your own customised schedule

Along with a number of pre-set schedules (see table in previous section) there is also one schedule that can be used to create your own custom timer settings. This schedule is represented by the initials 'UP' (user programmed).

*Step 1:*

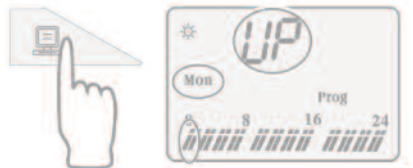
First select the 'UP' mode from the pre-set programme (see 'Selecting a pre-loaded schedule section').



Enter the 'UP' editing mode by selecting the  icon. The screen will display the current day of the week flashing. In the example the day in question is Monday (Mon).

*Step 2:*

Next select the day to programme. Simply press the timer icon until the required day is displayed. In this example we have selected Wednesday (Wed) which required two presses of the timer icon.



### Step 3:

Now the day is selected a value for every segment of a full day must be assigned (there are 24 in total). The programme will only be saved when this is complete. Use the up/down icon to allocate the mode for each segment. Up = 'peak' setting and down = 'Off peak'. In the below example the down button has been pressed eight times followed by the up button eight times and finally the down button eight times. This will mean the heater operates in 'off peak' temp from 00:00 to 08:00 and then 'peak' setting from 08:00 until 16:00 and then finally 'off peak' from 16:00 until 00:00.



To confirm and save this setting, press the INSERT SYMBOL icon. Next repeat the whole process for each of the remaining six days of the week.

## 5. Advanced features (7-day timer models)

### 5.1 Copy and paste programming



To make creating a 'UP' (custom schedule) slightly easier, you may wish to copy and paste a full day's programme onto another day. For instance, you have set Monday's programme and you wish to replicate this for the remaining week days. This can be achieved by copying and pasting Monday's settings on to the remaining days, this will negate the need to programme each segment for each day separately. Follow the below process:

#### Step 1:

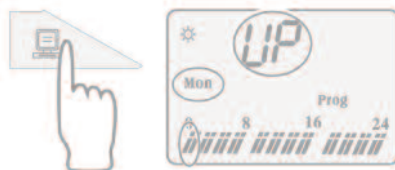
To enter the 'UP' programme from the default pre-sets see timer functions section. Enter the 'UP' editing mode by pressing the  icon. This will bring up the screen as shown.



#### Step 2:

To copy the Monday (Mon) programme, press the  icon. This will copy the programme and the screen will confirm this with the word 'Copy' displayed alongside the word 'Prog'. Note: to copy from a different day, select the required day using the clock icon before pressing the  icon.

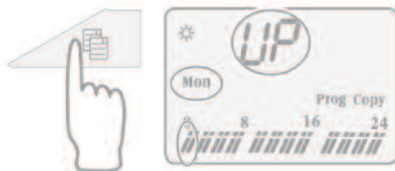

*Step 3:*

Press the timer icon the desired number of times to cycle to the day to programme to. In this example we have pressed the timer icon twice in order to display Wednesday (Wed).

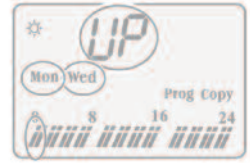

*Step 4:*

Press the  icon to complete the paste of the custom setting onto the desired day. In order to paste to more days you will need to exit the current screen using INSERT SYMBOL icon, and then returning to Step 1 of this section to repeat for other days.



### 5.2 Activating the child lock

The timer unit can be locked on your heater in order to prevent settings being altered.

*Step 1:*

Press the **P** icon once.

*Step 2:*

Push and hold the timer and programme icons for 2-3 seconds.

*Step 3:*

When the timer is successfully locked a 'key' icon will be displayed to confirm this.

*Step 4:*

To unlock the timer simply repeat the steps for locking.



### 5.3 Centigrade / Fahrenheit display

It is possible to switch the temperature setting between Fahrenheit (F) and Celsius (C).

Simply hold down the temp icon (°C) for approximately 3 seconds.



## 5.4 Delayed start and shut down mode

It is possible to turn the unit on automatically a number of hours in the future. For example, to automatically start in 10hrs time this can be achieved as follows:

### Step 1:

The heater must first be in standby mode. Press the alarm clock icon and a symbol of a clock will be displayed.



### Step 2:

Use the up/down icon to enter the number of hours to wait before the heater starts. In this example we have chosen ten hours which is achieved by pressing the up button ten times.



### Step 3:

Press the alarm icon again to exit timer mode and save the selection. The heater will now start up automatically in ten hours' time.



It is possible to programme the heater to switch off in a specified number of hours in the future.

### Step 1:

The heater must be On (not in standby) to utilise this feature. Press the alarm clock icon and a symbol for a clock will be displayed.

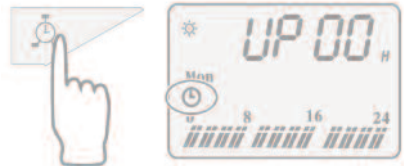

### Step 2:

Use the up/down icon to enter the amount of hours to wait before the heater goes into 'sleep' mode. In this example we have gone for ten hours which is achieved by pressing the up button ten times.



### Step 3:

Press the alarm icon again to exit timer mode and save the selection. The heater will now automatically go into 'sleep' mode in ten hours' time.

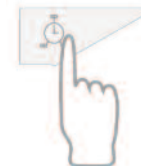

## 6. Maintenance

- Replacing the battery is required from time to time; the LCD will display the remaining charge of the battery.

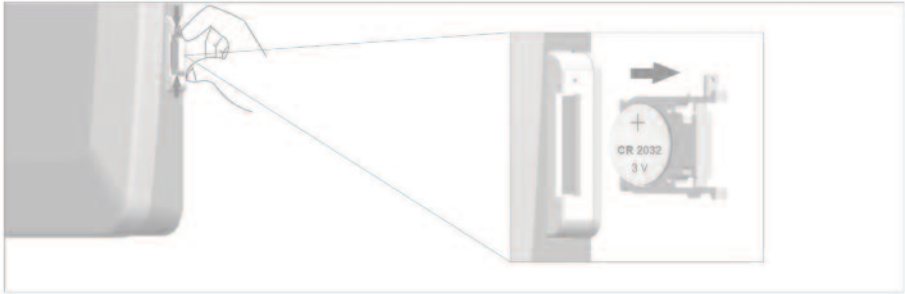

- Before cleaning, ensure the heater is disconnected from the mains supply and has completely cooled
- Wipe the exterior surfaces with a soft dry cloth
- Never use chemical or abrasive cleaners

## 7. Specifications

Model	AN500T	AN1000	AN1000T	AN1500	AN1500T	AN2000	AN2000T
Voltage	230v~ ~50Hz	230V ~50Hz	230V ~50Hz	230V ~50Hz	230V ~50Hz	230V ~50Hz	230V ~50Hz
Power	0.5kW	1.0kW	1.0kW	1.5kW	1.5kW	2.0kW	2.0kW
Weight	4.4kg	5.1kg	5.1kg	6.2kg	6.2kg	7.4kg	7.4kg
Dimensions (H x W x D)	440 x 445 x 98mm	440 x 580 x 98mm	440 x 580 x 98mm	440 x 700 x 98mm	440 x 700 x 98mm	440 x 855 x 98mm	440 x 855 x 98mm





INFORMATION FOR CORRECT DISPOSAL OF THE PRODUCT IN ACCORDANCE WITH THE EUROPEAN DIRECTIVE 2002/96/E.

At the end of its working life this equipment must not be disposed of as household waste. It must be taken to a local authority waste collection centre or to a dealer providing this service. Disposing of electrical and electronic equipment separately enables its components to be recovered and recycled to obtain significant savings in energy and resources. In order to underline the duty to dispose of this equipment separately, the product is marked with a crossed out dustbin.

## 8. Guarantee and service policy

This product is guaranteed against faulty materials and manufacture for a period of one year from the date of purchase. Hyco will in its sole discretion replace, repair or refund any faulty unit. Incorrect installation and failure to follow correct operating instructions are excluded. Consequential costs such as labour charges or damage to surroundings are expressly excluded.

Hyco Manufacturing Ltd  
Normandy Court  
Express Way  
Castleford, WF10 5NR

T 01924 225 200  
F 01924 225 210  
E [sales@hyco.co.uk](mailto:sales@hyco.co.uk)

[hyco.co.uk](http://hyco.co.uk)