

Code: 71R31PB-B

Hartland | HARTLAND RANGE | Rocker Switches

Product Image



Wiring

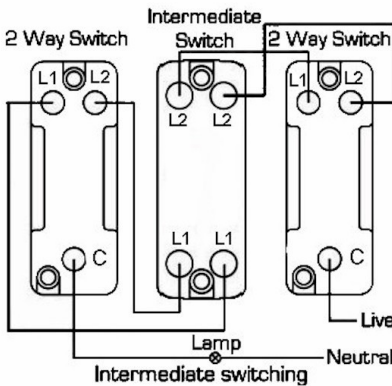

Dimensions

Hamilton®
HARTLAND
R31
Intermediate Rocker

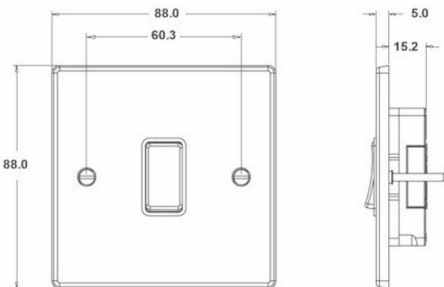

Insert Type	1 gang 10AX Intermediate Rocker
Insert Colour	Polished Brass/Black
EAN13 Barcode	5017503212316
Commodity Code	85363010
Luckins TSI	385549639
Dimensions(Nominal)	Single: Height = 88.0mm Width = 88.0mm Depth = 5.0mm
Switched Poles	Single
Current Rating	10AX
Voltage	220/250V AC
Maximum Load	10 Amp inductive
Mains Frequency	50Hz
IP Rating	IP2XD
Contact Gap Minimum	3mm
Terminal Capacity 1	5x1mm ²
Terminal Capacity 2	4x1.5mm ²
Terminal Capacity 3	1x2.5mm ²
Terminal Capacity 4	1x4mm ² Multi-strand
Terminal Capacity 5	1x6mm ²
Earth Terminal Capacity 1	5x1mm ²
Earth Terminal Capacity 2	4x1.5mm ²
Earth Terminal Capacity 3	3x2.5mm ²
Earth Terminal Capacity 4	1x4mm ² Multi-strand
Earth Terminal Capacity 5	1x6mm ²
Product Class 1	Must be earthed
Ambient Operating Temperature	-5° to +40°C
Recommended Location	Internal Use Only
Maximum Installation Altitude	2000m
Standard/Approval	BS EN 60669-1

R Hamilton & Co Ltd, Unit 10 Carrick Business Centre,
4-5 Bonville Road, Brislington, Bristol, BS4 5NZ

T: +44 (0)1747 860088

E: info@hamilton-litestat.com | **W:** www.hamilton-litestat.com

All accessories are manufactured under an accredited BS EN ISO 9001:2015 Quality Management System. It is the policy of the company to improve products as part of our development programme. Therefore, we reserve the right to alter designs and dimensions without prior notice. Illustrations and diagrams are reproduced within the limitations of reproduction and printing process and are not binding. Due to manufacturing processes we cannot guarantee an exact colour match and shadings of certain finishes. This datasheet was generated on 2/28/2023 11:06:23 AM E&OE