

⚠ Important Safety Notice

It is the responsibility of the person installing the electrical equipment to ensure that the installation meets the requirements of the IET wiring regulations and is therefore 'fit for purpose'. Factors such as correct selection of components, cable sizing, protective devices and Earth bonding are all critical and should be checked prior to full testing and power-up. Any other regulations applicable to the equipment being installed such as the Machinery Directive and current health and safety legislation must also be adhered to. All connections (including factory made) must be checked for the correct tightness prior to commissioning of the electrical installation. All connections should be checked periodically to ensure correct tightness.

DO NOT USE POWER TOOLS ON THESE PRODUCTS

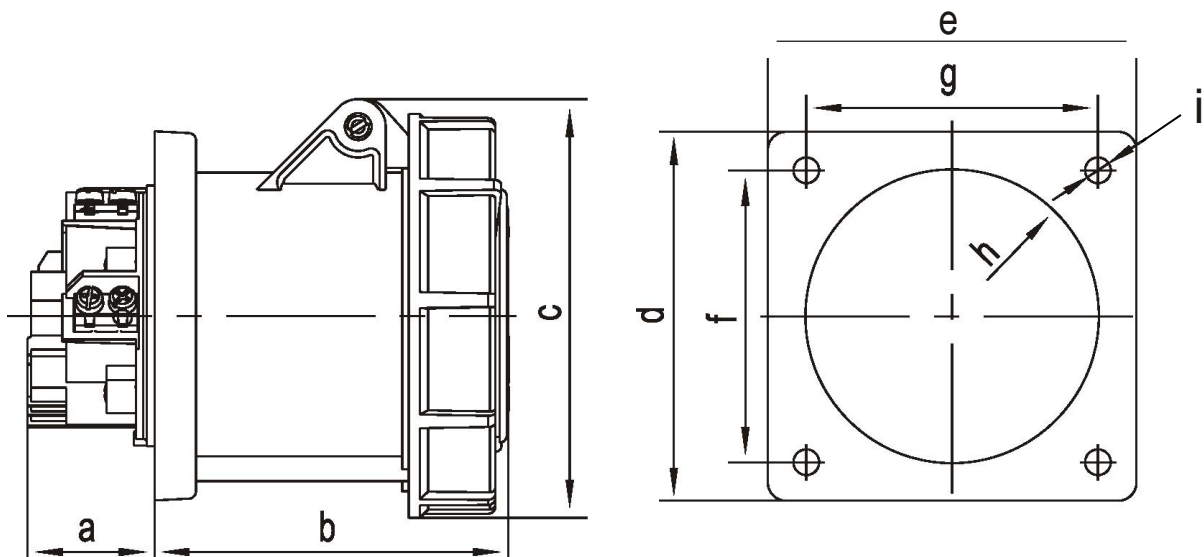

Part Number	Amps	Colour & Voltage	Poles	Protection Degree	a (mm)	b (mm)	c (mm)	d (mm)	e (mm)	f (mm)	g (mm)	h (mm)	i (mm)	Cable Nominal Cross Section Area
IPSW634N	63A	Red 415V	3P + N + E	IP67	35	96	114	101	101	79.5	79.5	80	7	6-16