



Technical Data

Round Pin And Export Socket Outlets

Brief product description:

The screwless slim line design in a range of finishes will blend with any décor - suitable for domestic or commercial installations.

Features:

- Fixed integrated plastic gasket to protect metal edges from moisture
- Under 5mm thick
- Flat profile with rounded edges
- Available in 4 metal finishes
- Secure easy "Clip on, Clip off frontplate design"
- Chrome range has choice of 2 insert colours
- Colour coded terminals with backed out captive screws for easy installation

Product Images

Black Nickel



FBN28B



FBN29B



FBN27B



FBN99B



FBN98B

Brushed Steel



FBS28G



FBS29G



FBS27G



FBS99G

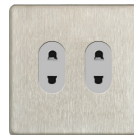

FBS98G

Polished Brass



FPB28B



FPB29B



FPB27B



FPB99B

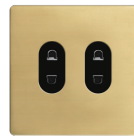

FPB98B

Polished Chrome



FPC28G



FPC29G



FPC27G



FPC99G



FPC98G



FPC28W



FPC29W



FPC27W



FPC99W



FPC98W

Round Pin And Export Socket Outlets

Technical Specifications

Standard(s)	BS 546
Rating	13 Amp 250V~
Switch type	Single pole
Contact Gap	3.0mm minimum
Terminal Capacity	3 x 2.5mm ² 3 x 4mm ² 2 x 6.0mm ²
RoHS Directive	No
WEEE Directive	No
Mounting Box Depth(Min)	25mm (Fxx28x, Fxx29x, Fxx98x products) 35mm (Fxx27x, Fxx99x products)
Fixing Centres	60.3mm
Size	87.4mm x 87.4mm x 32mm (Fxx27x products) 87.4mm x 87.4mm x 24mm (Fxx28x products) 87.4mm x 87.4mm x 23.6mm (Fxx29x products) 87.4mm x 87.4mm x 25.2mm (Fxx98x products) 87.4mm x 87.4mm x 31mm (Fxx99x products)

Line Diagrams

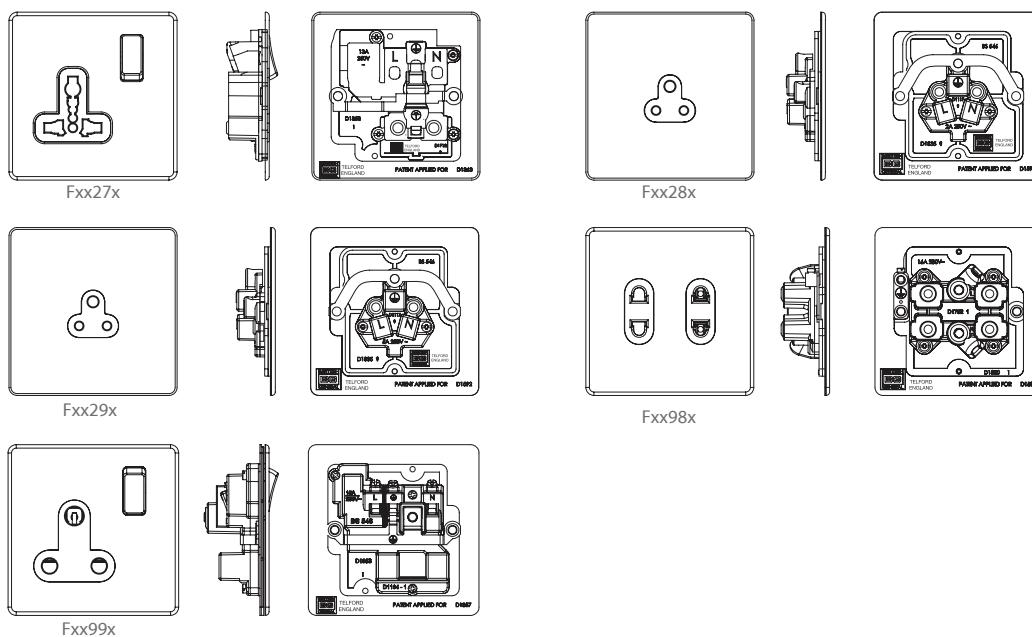

Weights & Dimensions

Cat No.	Description	Pack Quantity			Dimension (W x L x H) cm			Weight (g)			CMB (m ³) Outer Box
		Each	Inner Box	Outer Box	Product	Inner Box	Outer Box	Each	Inner Box	Outer Box	
Fxx28x	2A 1G, USW SKT	1	10	100	3.3 x 9 x 9.2	20 x 18 x 9.8	41.5 x 52.5 x 19	154	1640	17186	
Fxx29x	5A 1G, USW SKT	1	10	100	3.3 x 9 x 9.2	20 x 18 x 9.8	41.5 x 52.5 x 19	125	1350	14286	
Fxx27x	13A 1G UNI SKT	1	10	100	3.3 x 9 x 9.2	20 x 18 x 9.8	41.5 x 52.5 x 19				
Fxx99x	15A 1G, SW SKT	1	10	100	4.8 x 9 x 9.2	20 x 25.5 x 9.8	41.5 x 52.5 x 26.5	188	2005	20940	
Fxx98x	16A 2G Euro SKT	1	10	100	3.3 x 9 x 9.2	20 x 18 x 9.8	41.5 x 52.5 x 19	168	1780	18586	

Round Pin And Export Socket Outlets

Packaging Information

Cat No.	Description	Barcode			Cat No.	Description	Barcode		
		Individual	Inner Box	Outer Box			Individual	Inner Box	Outer Box
FBS28G	2A 1G, USW SKT	5050765006255	/	/	FBS99G	15A 1G, SW SKT	5050765006286	/	/
FPC28G	2A 1G, USW SKT	5050765005319	/	/	FPC99G	15A 1G, SW SKT	5050765005357	/	/
FPC28W	2A 1G, USW SKT	5050765005326	/	/	FPC99W	15A 1G, SW SKT	5050765005364	/	/
FPB28B	2A 1G, USW SKT	5050765018548	/	/	FPB99B	15A 1G, SW SKT	5050765018562	/	/
FBN28B	2A 1G, USW SKT	5050765006774	/	/	FBN99B	15A 1G, SW SKT	5050765006798	/	/
FBS29G	5A 1G, USW SKT	5050765006262	/	/	FBS98G	16A 2G Euro SKT	5050765006644	/	/
FPC29G	5A 1G, USW SKT	5050765005333	/	/	FPC98G	16A 2G Euro SKT	5050765005715	/	/
FPC29W	5A 1G, USW SKT	5050765005340	/	/	FPC98W	16A 2G Euro SKT	5050765005722	/	/
FPB29B	5A 1G, USW SKT	5050765018555	/	/	FPB98B	16A 2G Euro SKT	5050765018784	/	/
FBN29B	5A 1G, USW SKT	5050765006781	/	/	FBN98B	16A 2G Euro SKT	5050765007108	/	/
FBS27G	13A 1G UNI SKT	5050765006606	/	/	FBN27B	13A 1G UNI SKT	5050765018760	/	/
FPC27G	13A 1G UNI SKT	5050765005678	/	/	FBN27B	13A 1G UNI SKT	5050765007085	/	/
FPC27W	13A 1G UNI SKT	5050765005685	/	/					

Installation Information

Safety Warning

Before use please read carefully and use in accordance with these safety wiring instructions.

Before commencing any electrical work ensure the supply **is switched off at the mains**. Either by switching off the consumer unit or by removing the appropriate fuse.

Wiring should be in accordance with the latest edition of the IEE regulations (BS 7671).

Wire Identification – Twin & Earth Cable

EARTH = Green/Yellow Slewing

NEUTRAL = Black (pre Apr 04) / Blue (after Apr 04)

LIVE = Red (pre Apr 04) / Brown (after Apr 04)



Technical Helpline: 0845 194 7584
If in doubt consult a competent electrician.

The ends of the individual conductors should have the insulation removed by approx. 12mm. Any bare earth conductors should be sleeved to within 12mm of the ends. (These details are for general information only and conductor lengths may need to be trimmed in certain installations).

General Installation Instructions

- 1) If using the new product to replace an old one, note the cable connections and wire up new product in the same way as the old one, with Earthing as stated in these instructions.
- 2) Ensure the mounting box (metal or patress) for either flush or surface mounting is the appropriate size for the product.
- 3) Route the cable through the most suitable entry point of the mounting box. If a metal box is used, a protective cable grommet should be used.
- 4) Cables should be prepared so a sufficient conductor length reaches the terminals. Strip the ends of the individual conductors so that an adequate length enters the terminals.
- 5) Carefully arrange the wiring to lie along the edges of the product or box, keeping the central area clear.
- 6) To assist with the correct installation please consult the appropriate wiring diagram on this leaflet.
- 7) When connecting the new accessory ensure that only the bare end of the wire enters the terminal, and no bare wires are visible.

Always tighten the terminal screws securely, but do not overtighten.

An earth connection should always be made between the mounting box earth terminal, and the accessory earth terminal, where fitted. If this earth wire is bare, it is essential that it is sheathed with a length of green/yellow sleeving.

8) Carefully position the accessory into the wall box, ensuring that no wires are trapped between the plate and the wall. Do not overtighten the screws. (Fit screw covers + clip-on)

9) Once work has been completed correctly, replace the fuse for the circuit, switch the power back on, and test.

The product is now ready for use.

* Note - If your installation uses a four lug metal mounting box, remove the top and bottom lugs or bend fully back.

Decorative Front Plate Fixing

Fixing method varies depending on which product range is supplied. Always ensure wall surface is reasonably flat and smooth, with no bumps or projections.

Metal Front plates WITH screw fixing holes. These products comprise main unit with integral front plate and rear gasket. Fix unit to back box using two fixing screws supplied.

Front plates WITHOUT screw fixing holes. These products comprise main unit with integral gasket, and front plate as separate item. Fix unit to back box using two fixing screws supplied.

Clip front plate onto main assembly, ensuring screwdriver notch is located bottom right hand corner. To remove plate, place medium size flat bladed screwdriver in notch and lever off against gasket.

For all Decorative Plates - It is essential the gasket is fitted between product and wall, to reduce possibility of discolouration of front plate edges due to natural moisture in some wall finishes.

To keep the finish of this product, wipe over with soft cloth periodically.

All Decorative products MUST have an earth connection between the front-plate and back box

Round Pin And Export Socket Outlets

Installation Information

2 Amp Unswitched Socket

Connect the cables as shown in the diagram.

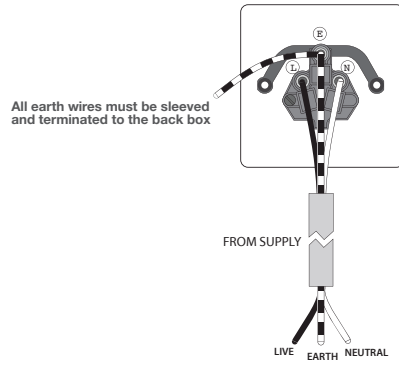

5 Amp Unswitched Socket

Connect the cables as shown in the diagram.

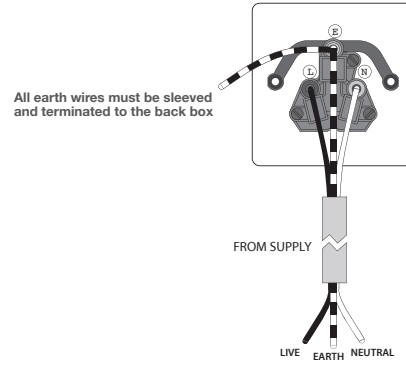

15 Amp Switched Socket

Connect the cables as shown in the diagram.

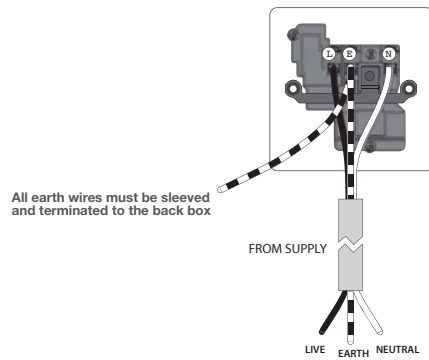

2 Gang Euro Socket

Connect the cables as shown in the diagram.

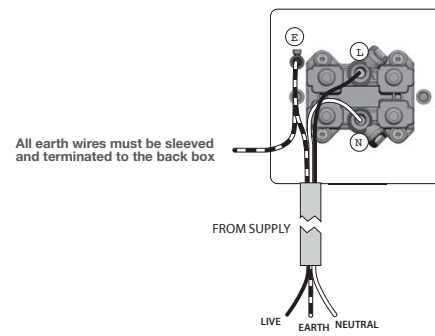

Universal Switched Socket

Connect the cables as shown in the diagram.

